

Booth

Your phone calls will
never be the same





Booth is a beautifully designed wall-mounted telephone hood that provides instant and temporary privacy.

DE

Booth ist eine formschön gestaltete Wand-Telefonhaube für sofortige und temporäre Ungestörtheit.

PL

Booth to pięknie zaprojektowana naścienna budka telefoniczna, która natychmiast zapewni Ci chwilę prywatności.

Defying the conventions of a traditional telephone Booth thanks to its smooth lines & curved profile, Booth envelops you in a velvety shelter and creates a comfortable, quiet zone for private phone calls. Booth is a highly technical product closed in a sensuous, unusual shape that will give your office interior a warm and soft touch.

DE

Mit ihrer weichen Linienführung und dem geschwungenen Profil entzieht sich Booth allen Konventionen einer herkömmlichen Telefonzelle und bietet eine angenehme Ruhezone für private Telefonate. Booth ist ein hochtechnisches Produkt in einer sinnlichen, ungewöhnlichen Form, das Ihrem Büro einen warmen und weichen Touch verleiht.

PL

Gładkie linie i zaokrąglony profil Booth przelamują konwencję tradycyjnej budki telefonicznej, otulając Cię aksamitną, komfortową przestrzenią, idealną dla prywatnych rozmów telefonicznych. Booth to wysoka technologia zamknięta w zmysłowym, niezwykłym kształcie, który pomoże stworzyć w biurze subtelną, kojącą atmosferę.



Subtle details, such as its rounded back, add to the Booth a lightweight & aerial feel, which can be enhanced by a marriage of 2 shades of the same fabric inside & outside. You can also decide to include a handbag hook to keep your bag safe and clean and be able to focus on your call.



DE

Dezente Details, wie die abgerundete Rückseite, verleihen Booth einen leichten, luftigen Touch, der durch die Kombination von zwei Farbtönen aus demselben Stoff auf der Innen- und Außenseite noch gesteigert werden kann. Sie können sich auch entscheiden, zusätzlich einen Taschenhalter anzubringen, damit Sie Ihre Tasche sicher und sauber verstauen und sich nur auf Ihren Anruf konzentrieren können.

PL

Subtelne detale, jak zaokrąglony tył, nadają Booth lekkość, którą można podkreślić łącząc dwa kolory tej samej tkaniny. Jeśli zdecydujesz się wyposażyc budkę w dodatkowy wieszak, Twoja torba pozostanie bezpieczna i czysta, co pozwoli Ci skupić się wyłącznie na rozmowie.

MuteDesign®

Fabrics

Evo

Composition: 100% polyester / Weight: 300g/m²



Sprint by Camira - standard colours

Composition: 100% polyester / Weight: 325g/m²



Sprint by Camira - longer delivery time

Composition: 100% polyester / Weight: 325g/m²



MEDLEY by Gabriel - standard colours

Composition: 100% polyester / Weight: 364g/m²

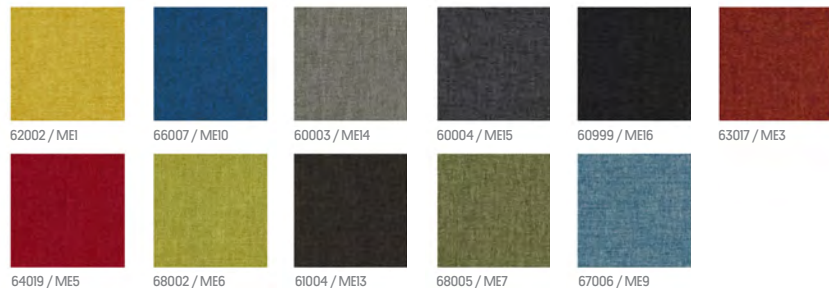

MEDLEY by Gabriel - longer delivery time

Composition: 100% polyester / Weight: 364g/m²

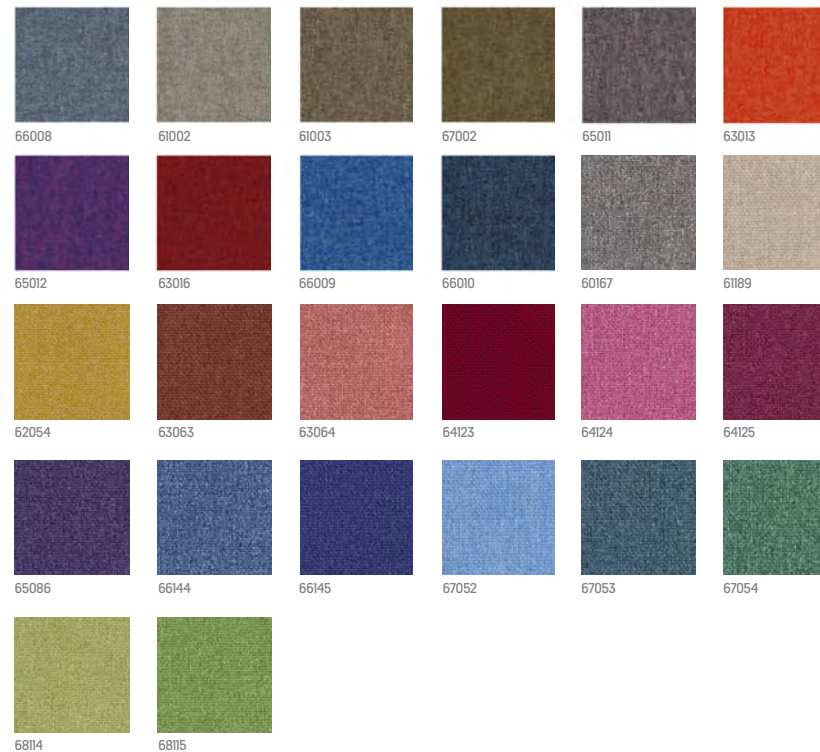

SYNERGY by Camira - standard colours

Composition: 95% wool, 5% polyamide / Weight: 400g/m²



SYNERGY by Camira - longer delivery time

Composition: 95% wool, 5% polyamide / Weight: 400g/m²



SYNERGY by Camira - longer delivery time

Composition: 95% wool, 5% polyamide / Weight: 400g/m²



REVIVE 1 by Kvadrat

Composition: 100% Recycled Flame Retardant Polyester / Weight: 300g/m²



REMIX 2 by Kvadrat

Composition: 90% New wool, 10% Nylon / Weight: 300g/m²



Booth Wall

Shapes & Sizes

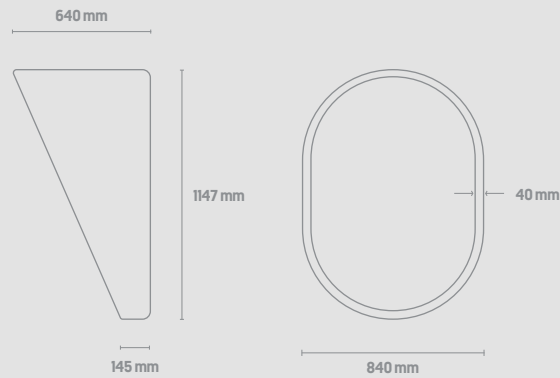

Acoustic function



Attenuation

Acoustic performance



Mid tones



High tones

MuteDesign®

Let us know if you need
more information!

Visit our website www.mute.design
or write to us at hello@mute.design



MICA™

by Gabriel

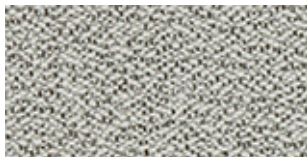

140 cm: 2496-60000
170 cm: 2500-60000

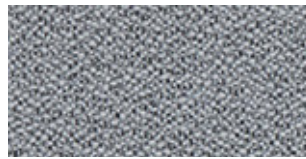

140 cm: 2496-60004
170 cm: 2500-60004



140 cm: 2497-60000
170 cm: 2501-60000

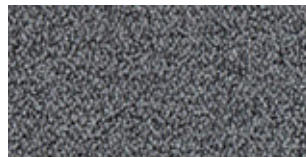

140 cm: 2497-60004
170 cm: 2501-60004

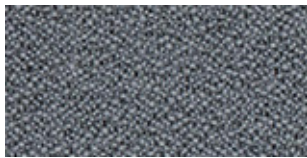

140 cm: 2496-60002
170 cm: 2500-60002

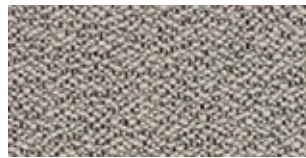

140 cm: 2496-61008
170 cm: 2500-61008

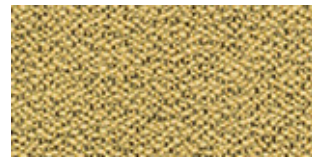

140 cm: 2496-62096



140 cm: 2497-60002
170 cm: 2501-60002

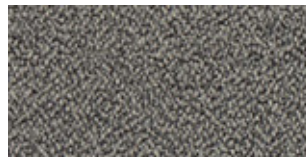

140 cm: 2497-61008
170 cm: 2501-61008

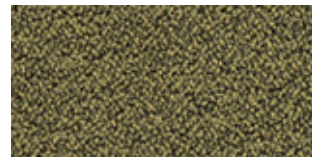

140 cm: 2497-62096

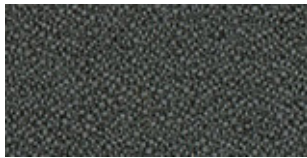

140 cm: 2496-60021
170 cm: 2500-60021

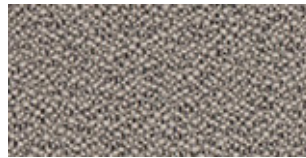

140 cm: 2496-61011
170 cm: 2500-61011

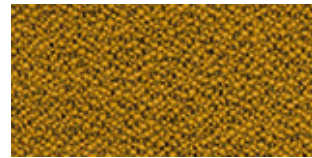

140 cm: 2496-62095



140 cm: 2497-60021
170 cm: 2501-60021

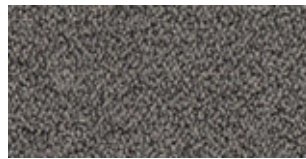

140 cm: 2497-61011
170 cm: 2501-61011

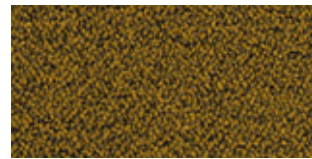

140 cm: 2497-62095

All colours are available in width 140 cm/55". 26 colours are also available in width 170 cm/67".
Contact customer service for other colours.

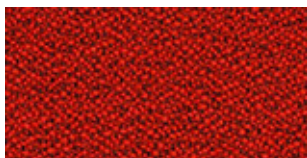

140 cm: 2496-64146
170 cm: 2500-64146

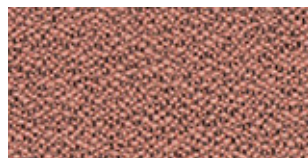

140 cm: 2496-64183

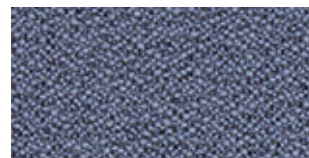

140 cm: 2496-65112

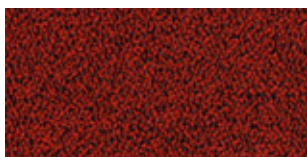

140 cm: 2497-64146
170 cm: 2501-64146

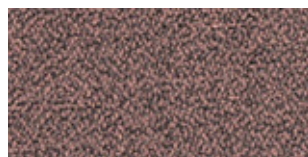

140 cm: 2497-64183

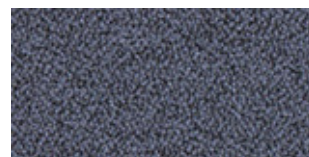

140 cm: 2497-65112

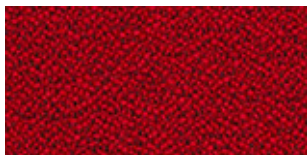

140 cm: 2496-64119

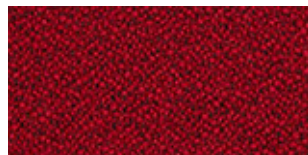

140 cm: 2496-64029

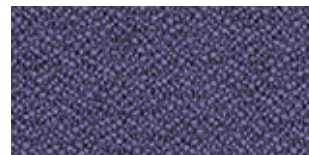

140 cm: 2496-66188



140 cm: 2497-64119

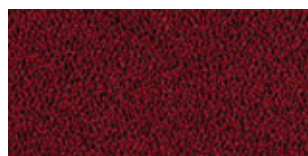

140 cm: 2497-64029

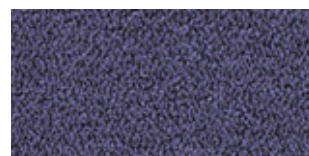

140 cm: 2497-66188

All colours are available in width 140 cm/55". 26 colours are also available in width 170 cm/67".
Contact customer service for other colours.

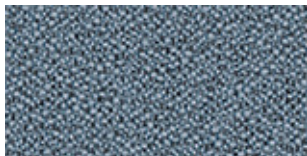

140 cm: 2496-66031

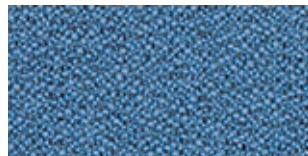

140 cm: 2496-66030
170 cm: 2500-66030

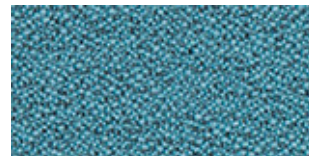

140 cm: 2496-67070
170 cm: 2500-67070

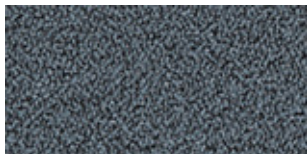

140 cm: 2497-66031

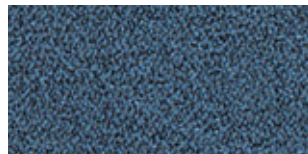

140 cm: 2497-66030
170 cm: 2501-66030

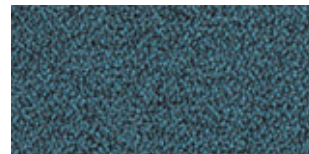

140 cm: 2497-67070
170 cm: 2501-67070

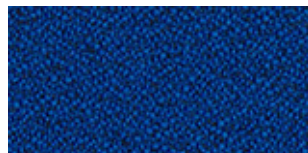

140 cm: 2496-66006
170 cm: 2500-66006

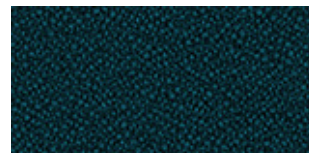

140 cm: 2496-67042

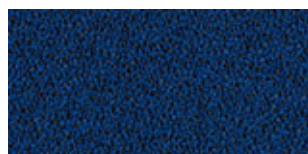

140 cm: 2497-66006
170 cm: 2501-66006



140 cm: 2497-67042

All colours are available in width 140 cm/55". 26 colours are also available in width 170 cm/67".
Contact customer service for other colours.

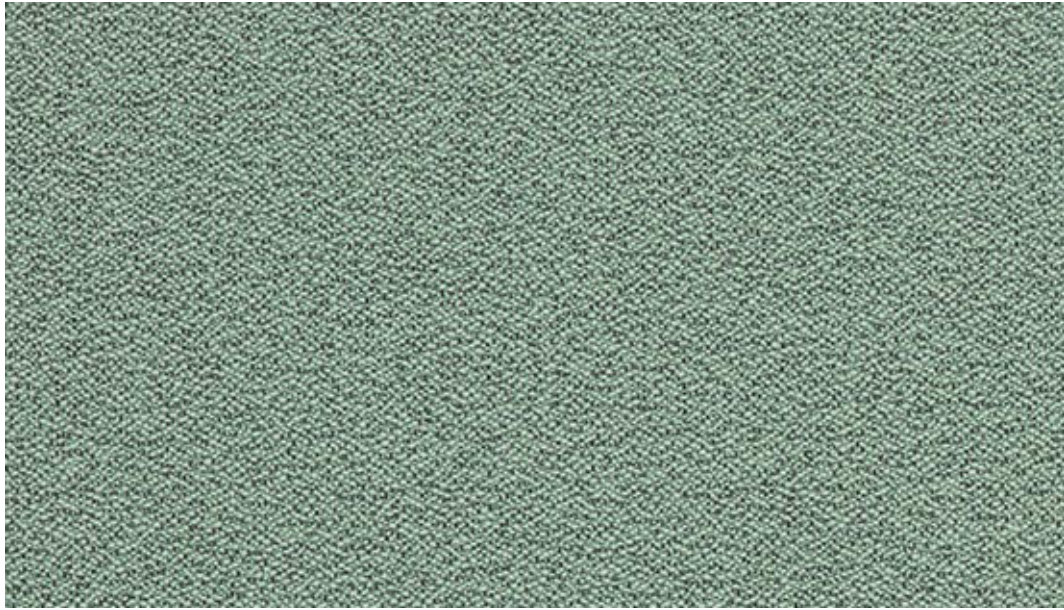

140 cm: 2496-67015
170 cm: 2500-67015

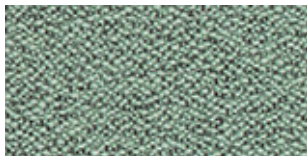

140 cm: 2496-67015
170 cm: 2500-67015

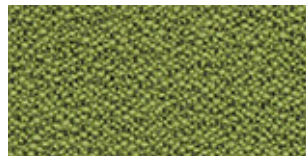

140 cm: 2496-68145
170 cm: 2500-68145



140 cm: 2496-62093
170 cm: 2500-62093

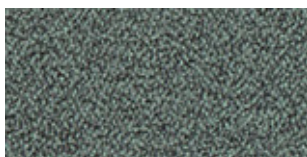

140 cm: 2497-67015
170 cm: 2501-67015

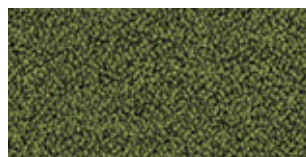

140 cm: 2497-68145
170 cm: 2501-68145

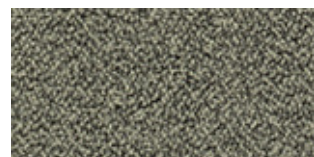

140 cm: 2497-62093
170 cm: 2501-62093

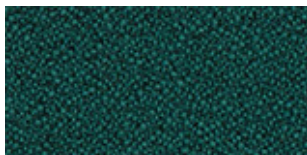

140 cm: 2496-67017

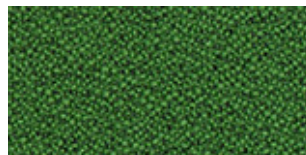

140 cm: 2496-68146

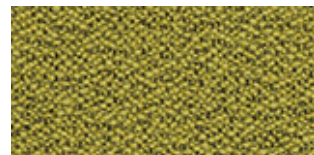

140 cm: 2496-62048

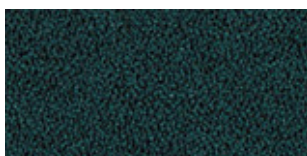

140 cm: 2497-67017

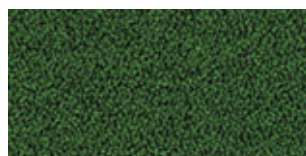

140 cm: 2497-68146

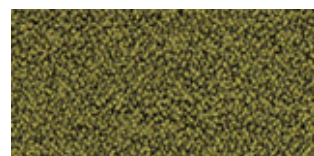

140 cm: 2497-62048

All colours are available in width 140 cm/55". 26 colours are also available in width 170 cm/67".
Contact customer service for other colours.

MICA™

Mica specifications: www.gabriel.dk

Please be aware that the PDF colour shades can appear different from the real fabric colours.
We advise you to request actual fabric samples before ordering.

Era

camira



Calendar
CSE19



Futurist
CSE01

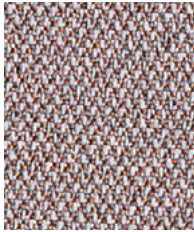

Occurrence
CSE23

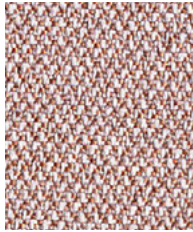

Date
CSE24

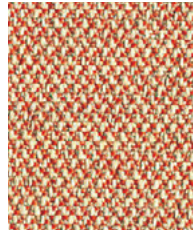

Sequence
CSE25



Generation
CSE02

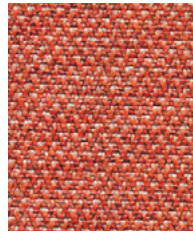

Turn
CSE26

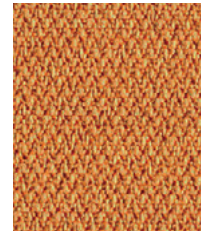

Measure
CSE27



Phase
CSE17



Cycle
CSE06

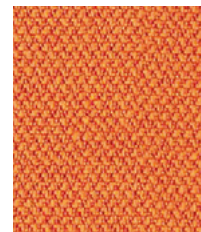

Span
CSE05



History
CSE21



Prime
CSE09

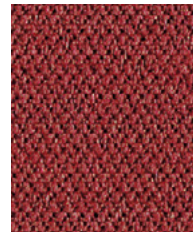

Extent
CSE28

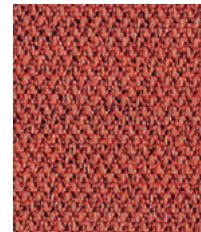

Experience
CSE29



Transition
CSE30

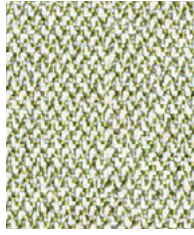

Analogue
CSE33

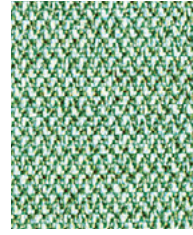

Notation
CSE36

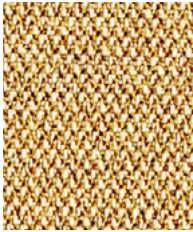

Splitsecond
CSE31

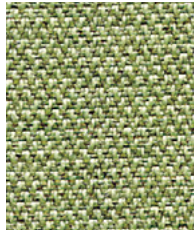

Endurance
CSE34

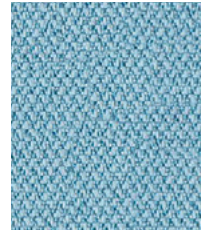

Aeon
CSE20

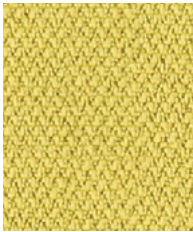

Lifetime
CSE03



Period
CSE07

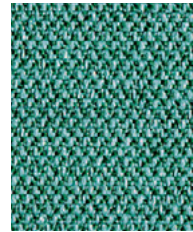

Rest
CSE37

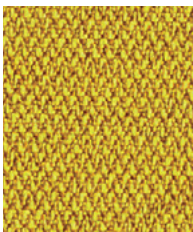

Occasion
CSE32

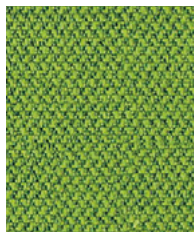

Timelapse
CSE16

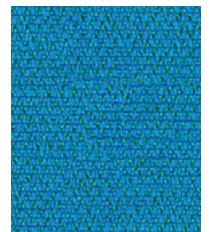

Everlasting
CSE10

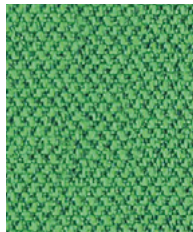

Event
CSE18

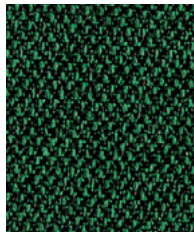

Signature
CSE35



Stage
CSE15

Photographic fabric scans are not colour accurate. Always request actual fabric samples before ordering.

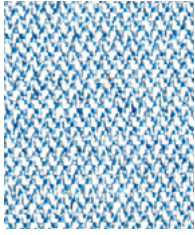

Allowance
CSE38

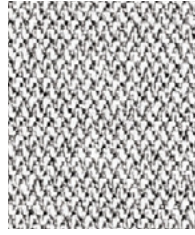

Memo
CSE46



Quota
CSE41

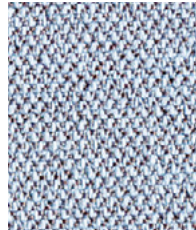

Youth
CSE39



Chapter
CSE08



Forecast
CSE11

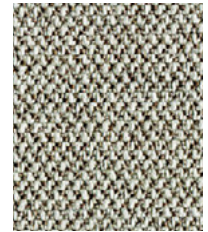

Prompt
CSE45

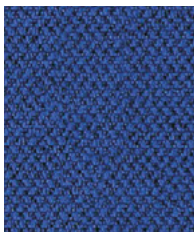

Perennial
CSE12

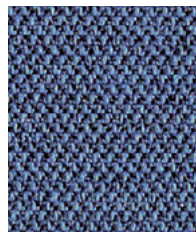

Range
CSE42

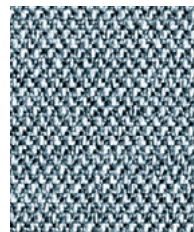

Late
CSE43



Present
CSE13

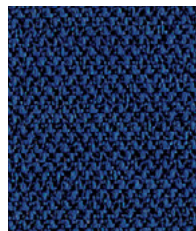

Maturity
CSE40

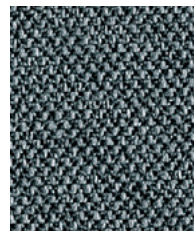

Elapse
CSE44

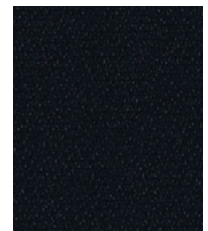

Forward
CSE14



Task seating



Soft seating

Cigarette
& Match

Washable



Year guarantee

Era is a subtle, two tone polyester fabric containing stretch in both directions for ease of upholstery. The baby herringbone weave offers an understated contemporary texture while its colouring technique provides close up intrigue. The palette incorporates playful brights and sophisticated muted tones.



Technical information

UK

Industry Application

Workplace, Education

Composition

100% Polyester

Environment

Certified to OEKO-TEX® Standard 100
Certified to Indoor Advantage™ Gold
Non metallic dyestuffs

Width

140 cm minimum

Weight

320 g/m² ±5% (448 g/lin.m ±5%)

Abrasion Resistance*

Heavy duty / 10 year guarantee
Independently certified to ≥100,000
Martindale cycles

Flammability

EN 1021 - 1 (cigarette)
EN 1021 - 2 (match)
BS 7176 Low Hazard
EN 13501-1 Adhered Class B, s1, d0
EN 13501-1 Un-adhered Class C, s1, d0
Note: Flammability performance is dependent on components used. Our certificates show what substrates have been used in our tests. For composite tests customers must ensure their complete furniture meets the necessary standards.

Light Fastness

5 (ISO 105 - B02)

Fastness to Rubbing

Wet: 4, Dry: 4 (ISO 105 - X12)

Cleaning

Washable to 60°C. Vacuum regularly.
Wipe clean with a damp cloth or shampoo
using proprietary upholstery shampoo.

*Abrasion testing produces a wide variability of results even from the same test sample. The independent certificate of ≥100,000 cycles is available on our website or from our customer service team. Internally we also specify this product at >100,000 cycles which we believe is realistic for repeatability of testing. Please be aware that abrasion testing alone is not a reliable indicator of the actual wear performance of fabrics. We're so confident in the durability of our products that we provide a robust 10 year guarantee (full details available).

Please note that seam performance is dependent on seam construction and needle and thread type. We recommend that appropriate sewing advice be taken.

Batch to batch variations in shade may occur within commercial tolerances. We reserve the right to alter technical specifications without notice. The Unregistered Design Rights and the Copyright in all designs are the exclusive property of Camira Fabrics Limited.

D

Einsatzbereich

Büro, Bildung

Zusammensetzung

100% Polyester

Umweltfreundlich

Nach Zertifikat OEKO-TEX® Standard 100
Nach Zertifikat Indoor Advantage™ Gold
Nicht schwermetallhaltige Farbstoffe

Breite

140 cm nutzbare Breite

Gewicht

320 g/m² ±5% (448 g/lfd.m ±5%)

Scheuerfestigkeit*

Schwerer Objekteinsatz / 10 Jahre Garantie
Extern zertifiziert mit ≥100,000
Scheuertouren Martindale

Feuersicherung

EN 1021 - 1 (Zigarettentest)
EN 1021 - 2 (Streichholztest)
BS 7176 Low Hazard
EN 13501-1 Adhered Class B, s1, d0
EN 13501-1 Un-adhered Class C, s1, d0
Bemerkung: Die Schwerentflammbarkeit hängt von den verwendeten Komponenten ab. Unsere Zertifikate zeigen auf, welche Substrate bei den Tests verwendet wurden. Bei Verbundtests muss sichergestellt sein, daß das komplette Möbel den entsprechenden Standards entspricht.

Lichtechtheit

5 (ISO 105 - B02)

Reibechtheit

Nass: 4, Trocken: 4 (ISO 105 - X12)

Reinigung

Waschbar bis 60°C. Regelmässig
staubsaugen. Dazu mit einem feuchten
Tuch abwischen, oder mit einem
speziellen Polsterschaum behandeln.

*Die Scheuerfestigkeitsprüfung ergibt selbst bei gleichen Testmustern stark abweichende Ergebnisse. Das Zertifikat eines unabhängigen Prüfinstitutes über ≥100,000 Scheuertouren erhalten Sie von unserem Vertriebsinnendienst oder auf unserer Webseite. Intern spezifizieren wir auch dieses Produkt mit >100,000 Scheuertouren, die in der Serienfertigung als realistisch angenommen werden. Bitte nehmen Sie zur Kenntnis, dass die Scheuerfestigkeitsprüfung allein keine Aussagekraft über die Langlebigkeit eines Bezugsstoffes hat. Wir sind von der Langlebigkeit unserer Produkte überzeugt und bieten daher 10 Jahre Garantie (Details auf Anfrage).

Eine optimale Nahtausreissfestigkeit hängt von der Nahtfahne, der verwendeten Nadel und dem Näh-Garn ab. Wir empfehlen daher Nähversuche durchzuführen.

Handelsübliche Farbabweichungen können auftreten und berechtigen nicht zur Reklamation. Wir behalten uns die Änderung technischer Spezifikationen vor. Die registrierten und nicht registrierten Urheberrechte der Dessinierungen sind ausschliessliches Eigentum der Camira Fabrics Limited.

F

Application industrielle

Lieu de travail, Education

Composition

100% Polyester

Écologique

Certifié à OEKO-TEX® Standard 100
Certificat indépendant à Indoor Advantage™ Gold
Teintures non métalliques

Largeur

140 cm minimum

Poids

320 g/m² ±5% (448 g/m.l ±5%)

Résistance à l'abrasion*

Usage intense / garantie 10 ans
Certificat indépendant ≥100,000 cycles
Martindale

Flammabilité

EN 1021 - 1 (cigarette)
EN 1021 - 2 (allumette)
BS 7176 Low Hazard
EN 13501-1 Adhered Class B, s1, d0
EN 13501-1 Un-adhered Class C, s1, d0
Notez: La performance de flammabilité dépend des composantes utilisées. Nos certificats indiquent les substrats utilisés dans nos tests. Pour les tests composites, les clients doivent s'assurer que leurs meubles complets satisfont aux normes nécessaires.

Solidité à la lumière

5 (ISO 105 - B02)

Solidité au Frottement

Mouillé: 4, Sec: 4 (ISO 105 - X12)

Nettoyage

Lavable jusqu'à 60°C. Aspirer
régulièrement. Essuyer avec une étoffe
humide ou nettoyer à l'aide d'un produit
approprié pour tissus d'ameublement.

*Les tests de résistance à l'abrasion proposent une large variété de résultat final, parfois sur le même échantillon de tissu. Le certificat indépendant de ≥100,000 cycles est disponible sur notre site internet; vous pouvez également contacter notre Service Clients. Nous validons également ce produit – en interne – à >100,000 cycles; ce qui est, d'après nous, plus réaliste dans le but d'obtenir une continuité égale des résultats de tests. Merci de noter que l'abrasion seule ne constitue pas un indicateur de confiance dans la performance du tissu à long terme. Nous avons une confiance absolue en nos produits et leur durabilité, c'est pour cela que nous vous offrons une garantie robuste de 10 ans.

Veuillez noter que la performance du joint dépend de sa construction ainsi que de l'aiguille et du type de fil utilisés.

Une variation de couleurs peut provenir (commercialement tolérable). Nous réservons le droit de changer les spécifications techniques sans préavis. Les Droits de Conception non-enregistrés et les droits d'auteur de tous les motifs sont la propriété exclusive de Camira Fabrics Limited.

ES

Aplicación Industrial

Puesto de Trabajo, Educación

Composición

100% Poliéster

Ambiental

Certificado de OEKO-TEX® Standard 100
Certificado de Indoor Advantage™ Gold
Tintes no metálicos

Ancho

140 cm mínimo

Peso

320 g/m² ±5% (448 g/lin.m ±5%)

Resistencia a la abrasión*

Garantía de 10 años con uso intenso
independientemente del certificado de
≥100,000 Ciclos Martindale

Inflamabilidad

EN 1021 - 1 (cigarillo)
EN 1021 - 2 (cerilla)
BS 7176 Low Hazard
EN 13501-1 Adhered Class B, s1, d0
EN 13501-1 Un-adhered Class C, s1, d0
Nota: El rendimiento de la inflamabilidad depende de los componentes usados. Nuestros certificados muestran qué substratos se han usado en nuestros tests. Para tests compuestos nuestros clientes deben asegurar si sus muebles cumplen la normativa al uso.

Solidez a la luz

5 (ISO 105 - B02)

Solidez al rozamiento

Húmedo: 4, Seco: 4 (ISO 105 - X12)

Limpieza

Lavable hasta 60°C. Limpiar con
aspiradora frecuentemente. Bien lavar
con un paño húmedo o con un champú
apropiado para tapicería.

*Los Test de Abrasión producen unos resultados muy variables incluso con la misma muestra. El certificado de ≥100,000 ciclos Martindale está disponible en nuestra web o se puede pedir al Departamento Comercial. Internamente también certificamos este producto >100,000 ciclos, que pensamos que es lo más realista posible en este caso, con una repetición de resultados tan dispares. Tengan en cuenta que el Test de Abrasión solo no es un indicador fiable sobre el desgaste de un tejido. De hecho, estamos tan convencidos en la durabilidad de nuestros tejidos, que ofrecemos una garantía de 10 años (detalles completos disponibles).

Tenga en cuenta que el rendimiento de la costura depende de la construcción de la costura, además de la aguja y del tipo de rosca. Le recomendamos que se aconsejen para coser la costura.

Las variaciones de lote a lote en la sombra se puede producir dentro de tolerancias comerciales. Nos reservamos el derecho a efectuar modificaciones técnicas sin previo aviso. Los derechos sobre los diseños no registrados y los derechos de autor en todos los diseños son propiedad exclusiva de Camira Fabrics Limited.

Sprint

camira

Photographic fabric scans are not color accurate. Always request actual fabric samples before ordering.

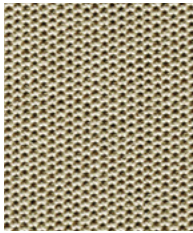

Hurdle
PS001

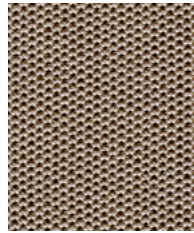

Relay
PS002

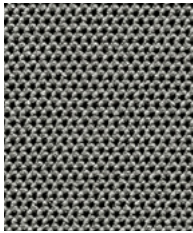

Block
PS029

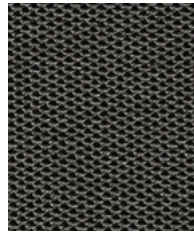

Speed
PS030

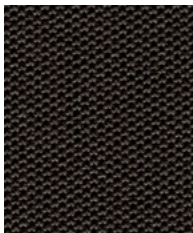

Exercise
PS025

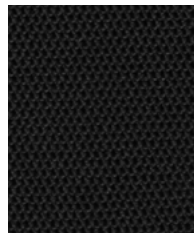

Chase
PS004

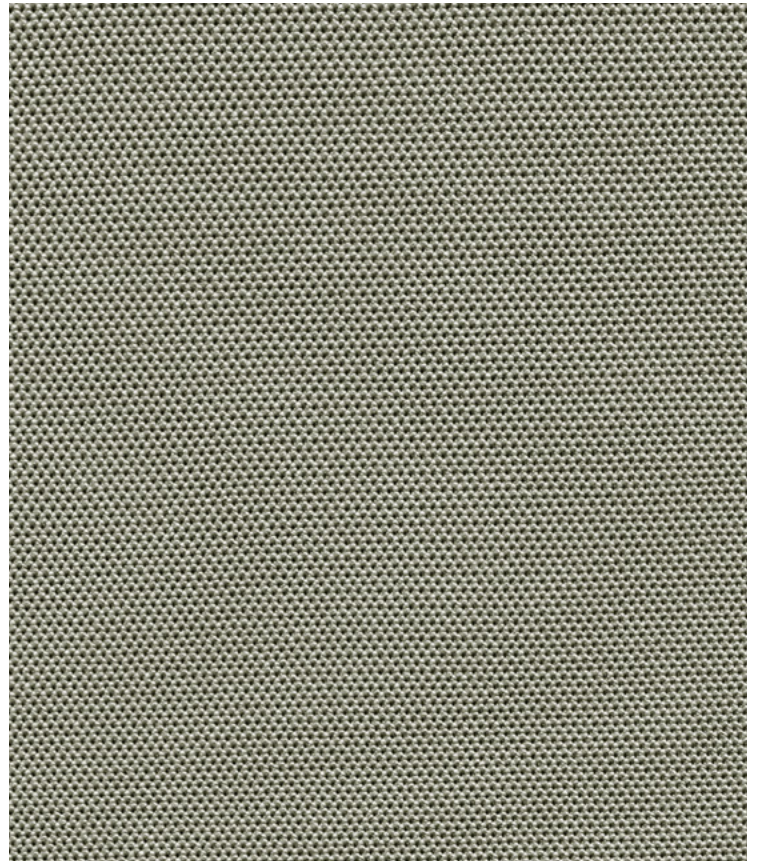

Silver
PS028

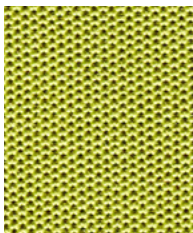

Energy
PS026

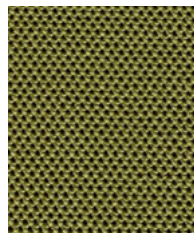

Train
PS027

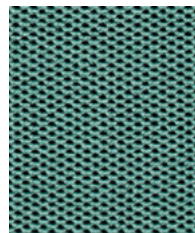

Champion
PS041

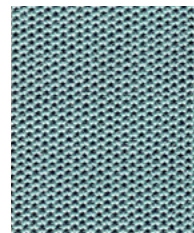

Nutrition
PS039

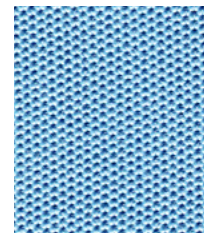

Stretch
PS031

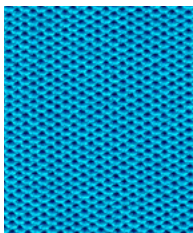

Victory
PS032

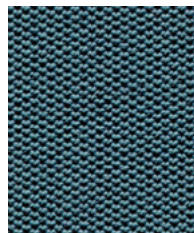

Competitor
PS040

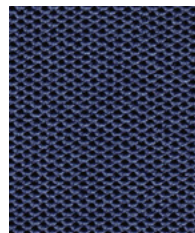

Line
PS033

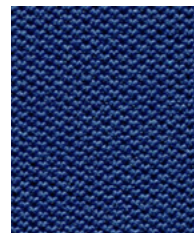

Heat
PS038

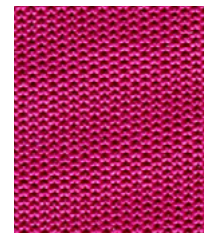

Ready
PS018

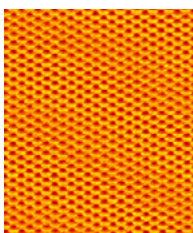

Gold
PS015

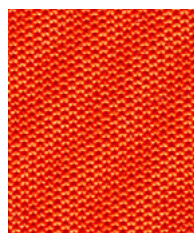

Plunge
PS016

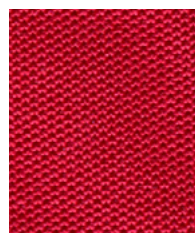

Runner
PS017

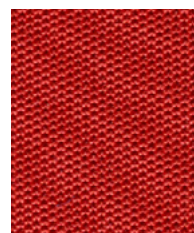

Start
PS010

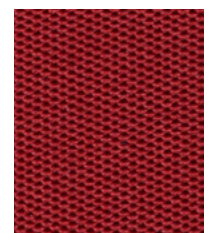

Finish
PS011



Task seating



Washable



Year guarantee

Sprint is a classic stretch knit product with a smooth macro cellular construction and a classic design that will stand the test of time. Sprint has multi-directional stretch for excellent upholsterability on task chair bases and backs.



Sprint meets the ACT voluntary Performance Guidelines and is classified for Heavy Duty Upholstery.

Technical information

EN

Composition
100% Polyester

Environment
Non metallic dyestuffs

Width
59 inches minimum

Weight
9^{1/2} oz/sq yd ±5% (15^{3/4} oz/running yd ±5%)

Abrasion Resistance*
ASTM D4157 Wyzenbeek method, Heavy Duty Upholstery
Independently certified to ≥100,000 double rubs
Covered by a full and comprehensive 10 year guarantee (full details available)

Flammability
California Technical Bulletin 117 - 2013
NFPA 260 + UFAC Class 1
BS 7176 Low Hazard
Note: Flammability performance is dependent on components used. Our certificates show what substrates have been used in our tests. For composite tests customers must ensure their complete furniture meets the necessary standards.

Color Fastness to Light
AATCC-16 (40 hours) Class 4

Color Fastness to Crocking
AATCC-8 (Dry: 4, Wet: 3)

Cleaning
W/S
Washable to 140°F. Clean with a water-based cleaning agent or solvent: Depending on the stain, you can use a dry-cleaning solvent, the foam of a mild detergent, or upholstery shampoo.

*Camira recognizes that the number of Wyzenbeek double rubs do not reflect the actual wear performance of fabrics. We're so confident in the durability of our products that we provide a robust 10 year guarantee (full details available). This product is externally certified, details of which are on our website and available from our customer services team.

Multiple factors affect fabric durability and appearance retention, including end-user application and correct maintenance. Results above 100,000 double rubs have not been shown to be a reliable indicator of increased fabric lifespan.

Batch to batch variations in shade may occur within commercial tolerances. We reserve the right to alter technical specifications without notice. The Unregistered Design Rights and the Copyright in all designs are the exclusive property of Camira Fabrics Limited.

F

Composition
100% Polyester

Écologique
Teintures non métalliques

Largeur
59 pouces minimum

Poids
9^{1/2} oz/sq yd ±5% (15^{3/4} oz/yd.lin ±5%)

Résistance à l'abrasion*
ASTM D4157 Wyzenbeek method, Heavy Duty Upholstery
Certificat indépendant ≥100,000 double frottement
Avec une garantie totale de durabilité de 10 ans (renseignements complémentaires disponibles)

Flammabilité
California Technical Bulletin 117 - 2013
NFPA 260 + UFAC Class 1
BS 7176 Low Hazard
Notez: La performance de flammabilité dépend des composantes utilisées. Nos certificats indiquent les substrats utilisés dans nos tests. Pour les tests composites, les clients doivent s'assurer que leurs meubles complets satisfont aux normes nécessaires.

Solidité à la Lumière
AATCC-16 (40 heures) Class 4

Solidité à la Crocking
AATCC-8 (Sec: 4, Mouillé: 3)

Nettoyage
W/S
Lavable jusqu'à 140°F. Nettoyer avec un produit d'entretien à base d'eau: en fonction de la tâche, vous pouvez nettoyer à sec, à l'aide d'un détergent ou bien avec du shampoing pour meubles.

*Camira reconnaît que le nombre de Wyzenbeek double frottement ne reflète pas la performance de l'usure réelle des tissus. Nous sommes tellement confiants dans la pérennité de nos produits que nous offrons une garantie solide de 10 ans (plus de détails disponibles). Cette gamme est certifiée externe, vous pouvez d'ailleurs trouver plus de détails sur notre site internet ou en contactant un membre de notre Service Clients.

La durabilité d'un tissu et sa capacité à conserver son aspect sont affectées par divers facteurs, y compris son environnement d'installation et son entretien. Un résultat de 100 000 ou plus (Wyzenbeek double frottement) n'est pas un indicateur fiable quant à la longévité d'un tissu.

Une variation de couleurs peut provenir (commerciallement tolérable). Nous réservons le droit de changer les spécifications techniques sans préavis. Les Droits de Conception non-enregistrés et les droits d'auteur de tous les motifs sont la propriété exclusive de Camira Fabrics Limited.

ES

Composición
100% Poliéster

Ambiental
Tintes no metálicos

Ancho
59 pulgadas mínimo

Peso
9^{1/2} oz/sq yd ±5% (15^{3/4} oz/lin.y ±5%)

Resistencia a la abrasión*
ASTM D4157 Wyzenbeek method, Heavy Duty Upholstery
independientemente del certificado de ≥100,000 rozamiento doble
Con garantía total de uso 10 años (más información disponible bajo consulta)

Inflamabilidad
California Technical Bulletin 117 - 2013
NFPA 260 + UFAC Class 1
BS 7176 Low Hazard
Nota: El rendimiento de la inflamabilidad depende de los componentes usados. Nuestros certificados muestran qué substratos se han usado en nuestros tests. Para tests compuestos nuestros clientes deben asegurar si sus muebles cumplen la normativa al uso.

Solidez a la Luz
AATCC-16 (40 horas) Class 4

Solidez al Rozamiento
AATCC-8 (Seco: 4, Húmedo: 3)

Limpieza
W/S
Lavable hasta 140°F. Lavar con un producto de limpieza neutro o solvente: en función de la suciedad o mancha, se puede limpiar con un producto de limpieza en seco, espuma templada o producto de limpieza de sofás.

*Camira reconoce que el número de Wyzenbeek rozamiento doble no refleja el rendimiento real del desgaste de los tejidos. Estamos tan seguros de la durabilidad de nuestros tejidos que ofrecemos una garantía íntegra de 10 años (los detalles completos están disponibles). Esta gama está certificada externamente, todos los detalles están disponibles en nuestra web y en el departamento de atención al cliente.

Muchos factores afectan la durabilidad y el aspecto del tejido, incluyendo el usuario final y el mantenimiento adecuado. Por encima de 100.000 (Wyzenbeek rozamiento doble), no se ha demostrado que indique una mayor durabilidad de los tejidos.

Se reserva el derecho de modificar las especificaciones técnicas sin previo aviso. Los derechos sobre dibujos no registrados y los derechos de autor sobre todos los dibujos son propiedad exclusiva de Camira Group Inc.